

# Eris® XT-Series E5 XT / E7 XT / E8 XT

## High-Definition Near Field Studio Monitors

Owner's Manual 用户手册

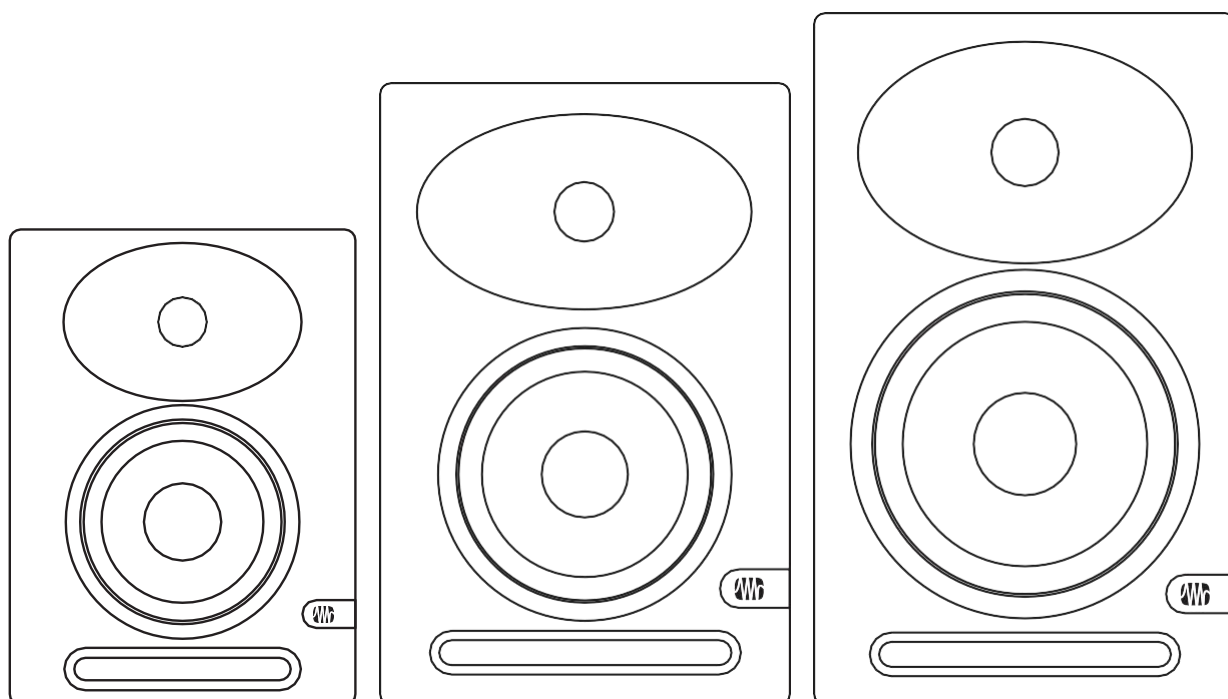

# Table of Contents 目录内容

## 1 Overview 概述 — 1

- 1.1 Introduction 介绍 — 1
- 1.2 Product Registration 产品注册 — 2
- 1.3 What's in the Box 都有什么 — 2
- 1.4 Companion PreSonus Products PreSonus 产品配备有 — 3

## 2 Hookup 连接 — 4

- 2.1 Rear Panel Connections and Controls 后面板连接和控制 — 4
  - 2.1.1 Inputs 输入 — 4
  - 2.1.2 Power 电源 — 4
  - 2.1.3 Acoustic Tuning Controls 声学调音控制 — 5
- 2.2 Hookup Diagrams 连接图 — 6
  - 2.2.1 Basic Setup 基本设置 — 6
  - 2.2.2 Advanced Setup with Monitor Controller and Speaker Switching 使用显示器控制器和扬声器开关的高级设置 — 7

## 3 Application Guide 应用指南 — 8

- 3.1 Monitor Placement and Acoustic Space Settings 监听器放置和声学空间摆放 — 8
- 3.2 Calibrating Using 85 dB SPL "Standard" Reference Reference 使用 85 dB SPL "标准" 参考值进行校准 — 10

## 4 Resources 相关资源 — 12

- 4.1 Technical Specifications 技术参数 — 12
- 4.2 Troubleshooting 故障排除 — 13

## 1 Overview

### 1.1 Introduction

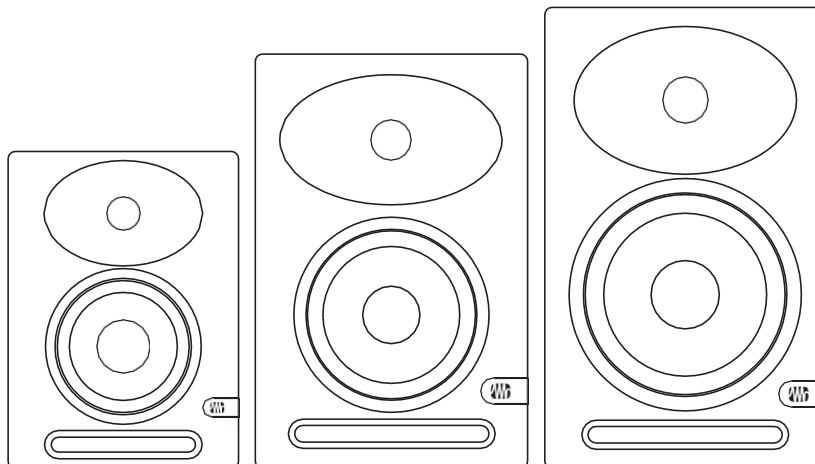

**Thank you** for purchasing Eris XT-series studio monitors. With their superb high-frequency response; extended low end; powerful amplification with tons of headroom; and acoustic tuning functions to mitigate any problem acoustics in your mix environment, Eris XT-series studio monitors ensure your mix translates from the studio to the stereo.

PreSonus Audio Electronics is committed to constant product improvement, and we highly value your suggestions. We believe the best way to achieve our goal of constant product improvement is by listening to the real experts; our valued customers. We appreciate the support you have shown us through the purchase of this product and are confident that you will enjoy your Eris XT-series studio monitors.

**About this manual:** We suggest that you use this manual to familiarize yourself with the features, applications, and workflows for your Eris XT-series studio monitors before trying to connect it to the rest of your studio equipment. This will help you to get better performance and results.

Throughout this manual you will find **Power User Tips** that can quickly make you an Eris expert so you can get the most out of your investment. If this is your first pair of studio monitors, please take a look at Section 3 for details on setting them up properly in your mix environment. More information is available at [www.presonus.com/learn/technical-articles](http://www.presonus.com/learn/technical-articles).

感谢您购买Eris XT系列录音室监听器。凭借其卓越的高频响应；扩展的低频；强大的放大能力和巨大的净空；以及声学调谐功能，以减轻您的混音环境中的任何问题。

Eris XT系列录音室监听音箱具有超强的高频响应；扩展的低频；强大的放大能力和巨大的净空；以及声学调谐功能，以减轻混音环境中的任何问题声学，确保你的混音从录音室转化为立体声。

PreSonus音频电子公司致力于不断改进产品，我们高度重视您的建议。我们相信，实现我们不断改进产品目标的最佳方式是听取真正的专家，即我们尊贵的客户的意见。我们感谢您通过购买该产品对我们的支持，并相信您会喜欢您的Eris XT系列录音室监听器。



关于本手册。我们建议你在尝试将Eris XT-系列演播室监听器与其他演播室设备连接之前，使用本手册来熟悉它的功能、应用和 workflows。这将有助于你获得更好的性能和效果。

在这本手册中，你会发现一些强大的用户提示，可以让你迅速成为Eris专家，这样你就可以从你的投资中获得最大的收益。如果这是你的第一对录音室监听器，请看第3节，了解在混音环境中正确设置它们的细节。更多信息可在 [www.presonus.com/learn/technical-articles](http://www.presonus.com/learn/technical-articles)。

## 1.2 Product Registration

PreSonus is committed to delivering the best experience for our customers. MyPreSonus is a one-stop portal for all our registered customers' needs. From your my PreSonus account, you can view all your PreSonus hardware and software registrations; contact support; track orders and more.

Don't have a My.PreSonus account yet? Here's why you should sign up.

-  One account gets you everything you need, from support to forums to product info and upgrades. Get the inside track on training videos, tutorials, special offers, and advance notifications.
-  Register a product on My.PreSonus and you're eligible for technical support, timely updates, expedited warranty service and quick tracking should you ever need repair. You also get special promotions that are members only!
-  Join the ever-growing community of PreSonus users and share ideas, projects, and yes, gripes on our forum and blogs. It's a lively, Cajun-tinged vibe and it's waiting for you.

[Create My.PreSonus Account](#)

To register your Eris XT studio monitor, go to [My.PreSonus.com](http://My.PreSonus.com) and follow the onscreen instructions.

PreSonus致力于为我们的客户提供最佳体验。我的PreSonus是一个满足我们所有注册客户需求的一站式门户。

通过我的PreSonus账户，您可以查看您所有的PreSonus硬件和软件注册；联系支持；跟踪订单等等。

要注册您的Eris XT工作室监听器，请访问 [My.PreSonus.com](http://My.PreSonus.com)，并按照屏幕上的指示操作。

OR 或者



Download the MyPreSonus app from the Apple App Store or Google Play. 从Apple App Store或Google Play下载MyPreSonus应用程序。

## 1.3 What's in the Box

Your Eris XT package contains the following

你的Eris XT软件包包含以下内容：

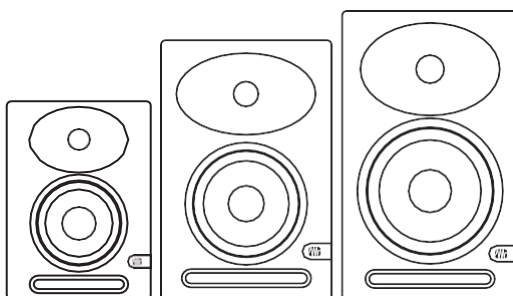

Eris E5XT, Eris E7XT, or Eris E8XT studio monitor

Eris XT Quick Start Guide 快速入门指南

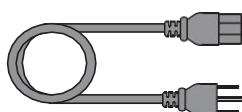
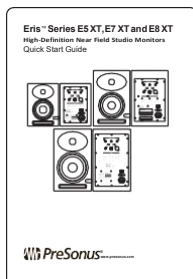

IEC Power Cable

IEC 电源电缆

## 1.4 Companion PreSonus Products PreSonus 产品

Thanks for choosing PreSonus! As a solutions company, we believe the best way to take care of our customers (that's you) is to ensure that you have the best possible experience from the beginning of your signal chain to the end. To achieve this goal, we've prioritized seamless integration throughout every design phase of these products from day one. The result is systems that communicate with each other as intended—straight out of the box—without excessive configuration hassles.

We're here for you. Find out more at [www.presonus.com](http://www.presonus.com)

感谢你选择PreSonus! 作为一家解决方案公司, 我们相信照顾客户(也就是你)的最佳方式是确保你从信号链的起点到终点都能获得最佳体验。为了实现这一目标, 我们从第一天起就把无缝集成放在这些产品的每个设计阶段。其结果是系统之间的相互沟通 直接开箱即用, 没有过多的配置麻烦。我们在这里为你服务。了解更多信息: [www.presonus.com](http://www.presonus.com)



## 2 Hookup 连接

### 2.1 Rear Panel Connections and Controls 后面板的连接和控制

#### 2.1.1 Inputs 输入

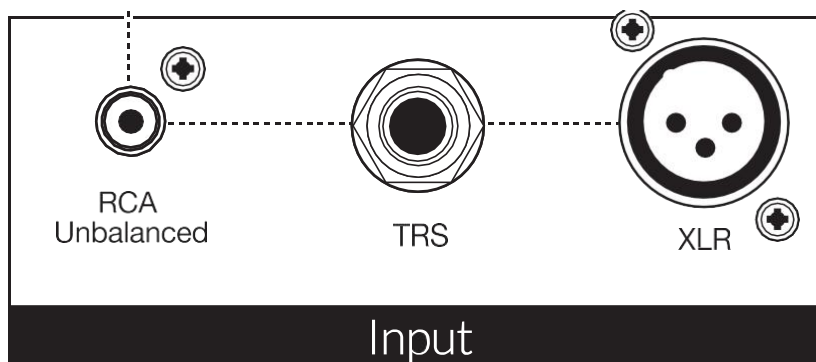

**Line-level Inputs.** The Eris XT studio monitors provide a choice of three line-level input types: balanced XLR, balanced 1/4" TRS, and unbalanced RCA. Do not connect more than one source to your Eris XT studio monitors simultaneously.

**Power User Tip:** Whenever possible, it is recommended that you utilize the balanced line-level inputs on your Eris XT studio monitors. Balanced cables and connections are resistant to induced noise from radio frequencies and electromagnetic interference (RFI and EMI). If your audio source has only unbalanced connections (either 1/4" TS or RCA), it is recommended that the RCA input be used. 1/4" TS-to-RCA cables and adapters are readily available at most music supply stores. Whether utilizing the balanced or unbalanced inputs, always use the shortest cable length possible to minimize the risk of induced noise in your studio monitors.

**线路电平输入。** Eris XT录音室监听器提供了三种线级输入类型的选择：平衡XLR、平衡1/4" TRS和不平衡RCA。不要同时将一个以上的信号源连接到Eris XT工作室监听器上。

**电源用户提示。** 只要有可能，建议你利用Eris XT录音室监听器上的平衡线级输入。平衡电缆和连接可以抵抗来自无线电频率和电磁干扰（RFI和EMI）的诱导噪音。如果你的音源只有非平衡连接（1/4" TS或RCA），建议使用RCA输入。1/4" TS-RCA电缆和适配器在大多数音乐用品商店都能买到。无论使用平衡或非平衡输入，都要尽可能使用最短的电缆长度，以减少录音室监听中的诱发噪音的风险。



Gain

**Input Gain.** Sets the level of the input signal before it is amplified.

输入增益。设定输入信号在被放大之前的电平。

### 2.1.2 Power 电源

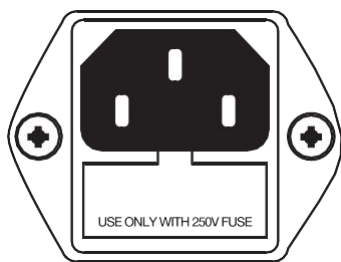

100-120V~, 50-60Hz, T2AL  
220-240V~, 50-60Hz, T1 AL  
160W

**IEC Power Connection.** This is the power inlet for your Eris XT studio monitor.  
IEC电源连接。这是Eris XT工作室监听器的电源入口。

**Warning:** Do not remove the center grounding prong or use a ground-lift adapter, as this could result in electric shock.

警告。不要拔掉中间的接地线，也不要使用接地线适配器，因为这可能会导致电击。

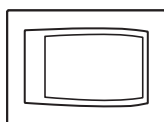

Power

**Power Switch.** This is the On/Off switch for your Eris XT studio monitor. When your Eris XT studio monitor is powered On, the blue LED on the front panel will illuminate.

电源开关。这是Eris XT录音室监听器的开/关开关。当你的Eris XT演播室监听器通电后，前面板上的蓝色LED会亮起。



AC Select

**AC Select Switch.** The input-power voltage is set at the factory to correspond with the country to which the Eris XT studio monitor was shipped. Use this switch only if you are using your Eris monitor in a country that uses a different standard voltage than is used in the country where you purchased your monitor originally.

**AC 选择开关。** 输入电源电压是在工厂设置的，与Eris XT演播室监听的国家相对应。Eris XT演播室监听器的国家。只有在以下情况下才使用这个开关 你在一个使用不同标准电压的国家使用你的Eris监听器时，才使用这个开关。只有当你在一个使用不同标准电压的国家使用你的Eris监听音箱时，才可以使用这个开关，而不是在你最初购买监听音箱的国家。

2.1.3 Acoustic Tuning Controls 声学调谐控制

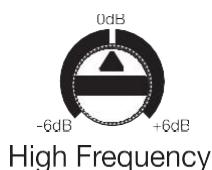

**High Frequency.** Boosts or cuts all frequencies above 10 kHz by  $\pm 6$  dB.

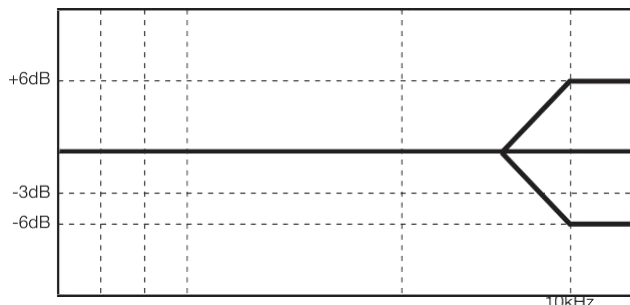

**Power User Tip:** The High control on the Eris XT studio monitors is a high-shelf EQ and raises or lowers all frequencies above 10 kHz. This EQ is much like the treble control on a car stereo and likewise can make big changes to the sound very quickly. If you find your mixes are translating too dark on other speaker systems, try lowering this control. Too bright? Raise this control a bit. In either case, anomalies in your room may be negatively impacting your Eris XT studio monitors' performance. **See Section 3 for set-up and calibration tips.**

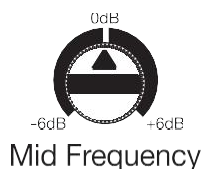

**Mid Frequency.** Boosts or cuts frequencies around 1 kHz by  $\pm 6$  dB.

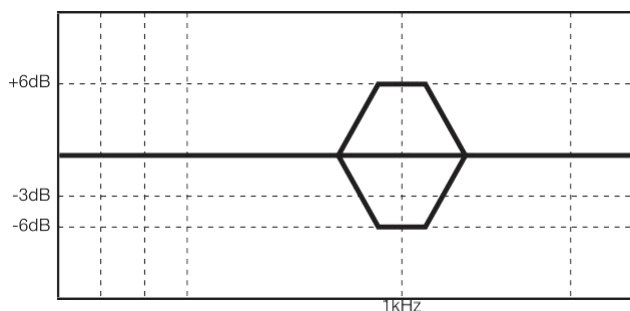

**Power User Tip:** The Mid control is a peak EQ that lets you raise or lower the level of a two-octave-wide frequency band centered at 1 kHz that can make subtle changes to the frequency response of your Eris XT monitors. In general, you will not want to alter this control as it will change the flat frequency response of your Eris XT monitors. However, if you would like to quickly emulate the performance of consumer speakers, lowering this control will mimic the mid-range scoop that is the hallmark of consumer designs.

Low Cutoff



**Low Cutoff.** Rolls off the level of all frequencies below the specified frequency (80 or 100 Hz) at a slope of -12 dB / octave. Setting this control to Flat allows the Eris XT's natural roll off to take over.

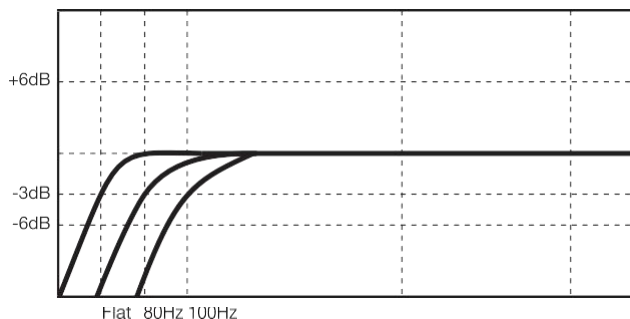

**Power User Tip:** If you are using a subwoofer that doesn't feature a variable low pass filter, like the PreSonus Temblor T10 provides, you will use this control to set the crossover point for your 2.1 system. **For information on configuring a 2.1 system in the studio, please visit [www.PreSonus.com/Learn/Technical-Articles](http://www.PreSonus.com/Learn/Technical-Articles).**



**高频。**将10kHz以上的所有频率提升或削减±6dB。

**电源用户提示。**Eris XT录音室监听音箱上的高频控制是一个高架EQ，提高或降低10kHz以上的所有频率。这个EQ很像汽车音响上的高音控制，同样可以很快地对声音做出很大的改变。如果你发现你的混音在其他扬声器系统上转化得太暗，可以尝试降低这个控制。太亮了？把这个控制调高一点。无论哪种情况，你的房间里的异常情况都可能对你的Eris XT录音室监听器的性能产生负面影响。请参阅第3节，了解设置和校准技巧。

**中频。**将1kHz左右的频率提升或削减±6dB。

**电源用户提示。**中音控制是一个峰值均衡器，可以让你提高或降低以1kHz为中心的两个倍频程的频带水平，可以对Eris XT监听器的频率响应进行微妙的改变。一般来说，你不会想改变这个控制，因为它将改变你的Eris XT显示器的平坦频率响应。然而，如果你想快速模仿消费类扬声器的性能，降低这个控制将模仿中频勺，这是消费类设计的标志。

**低截止。**以-12dB/倍频程的斜率滚去低于指定频率（80或100Hz）的所有频率的电平。把这个控制设置为平坦，可以让Eris XT的国家滚降功能接管。

**电源用户提示：**如果你使用的是没有可变低通滤波器的低音炮，比如PreSonus Temblor T10提供的低通滤波器，你将使用这个控制来设置2.1系统的分频点。有关在工作室配置2.1系统的信息，请访问[www.PreSonus.com/Learn/Technical-Articles](http://www.PreSonus.com/Learn/Technical-Articles)。

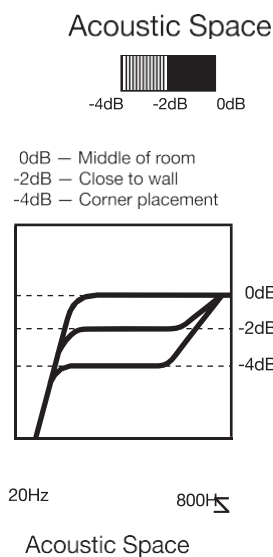

**Acoustic Space.** Cuts the level of all frequencies below 800 Hz by either -4 dB or -2 dB to compensate for the bass boost that naturally occurs when a speaker is placed near a wall or a corner. If your Eris XT monitors can be placed away from the walls in your mix space, leave this control set to 0 dB.

**Power User Tip:** The closer your studio monitors are to a wall or a corner, the more the boundary bass will be boosted. If you notice your mixes lack low end when played away from your mix environment, try adjusting the Acoustic Space to create a more even frequency response and help to mitigate a compact mix position. **For more information on studio monitor placement, please review Section 3.1.**

**声学空间。**将800赫兹以下的所有频率的电平削减4分贝或2分贝，以补偿扬声器靠近墙壁或角落时自然产生的低音增强。如果您的Eris XT监听音箱可以远离您的混音空间中的墙壁，请将此控制设置为0dB。

**电源用户提示。**你的录音室监听音箱离墙或角落越近，边界低音就会被提升得越多。如果你注意到你的混音在远离你的混音环境下播放时缺乏低频，可以尝试调整声学空间来创建一个更均匀的频率响应，并帮助缓解紧凑的混音位置。更多关于录音室监听位置的信息，请查看第3.1节。

2.2.1 Basic Setup 基本设置



Audio Interface (Studio 1824c)

Eris E8 XT

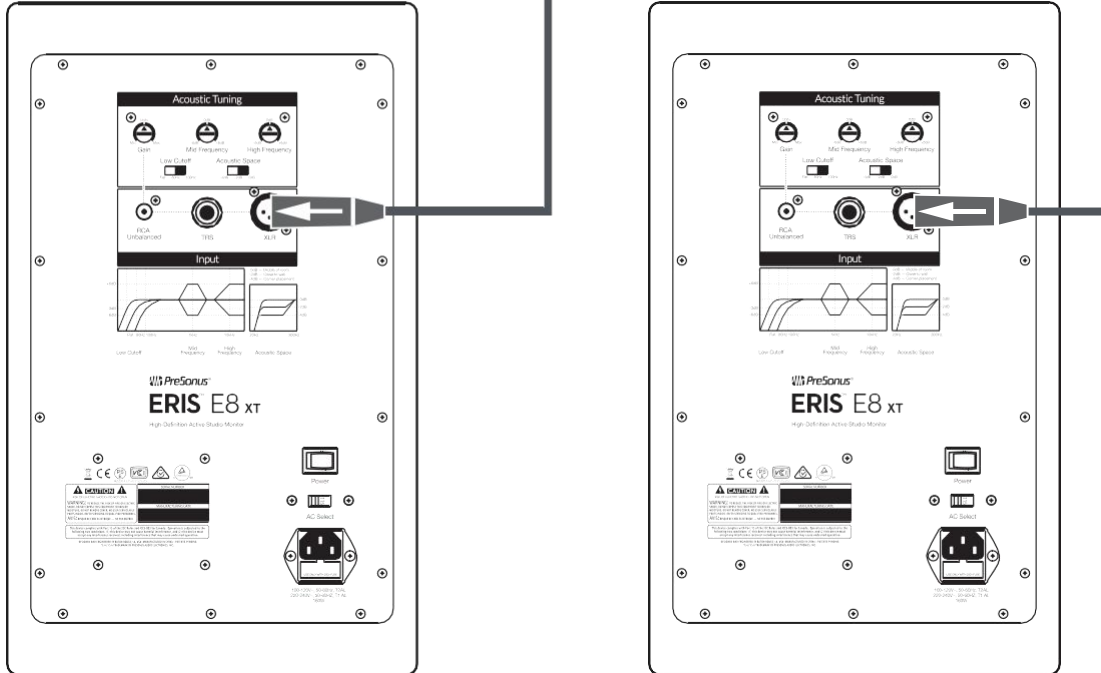

2.2.2 Advanced Setup with Monitor Controller and Speaker Switching 使用显示器控制器和扬声器切换的高级设置

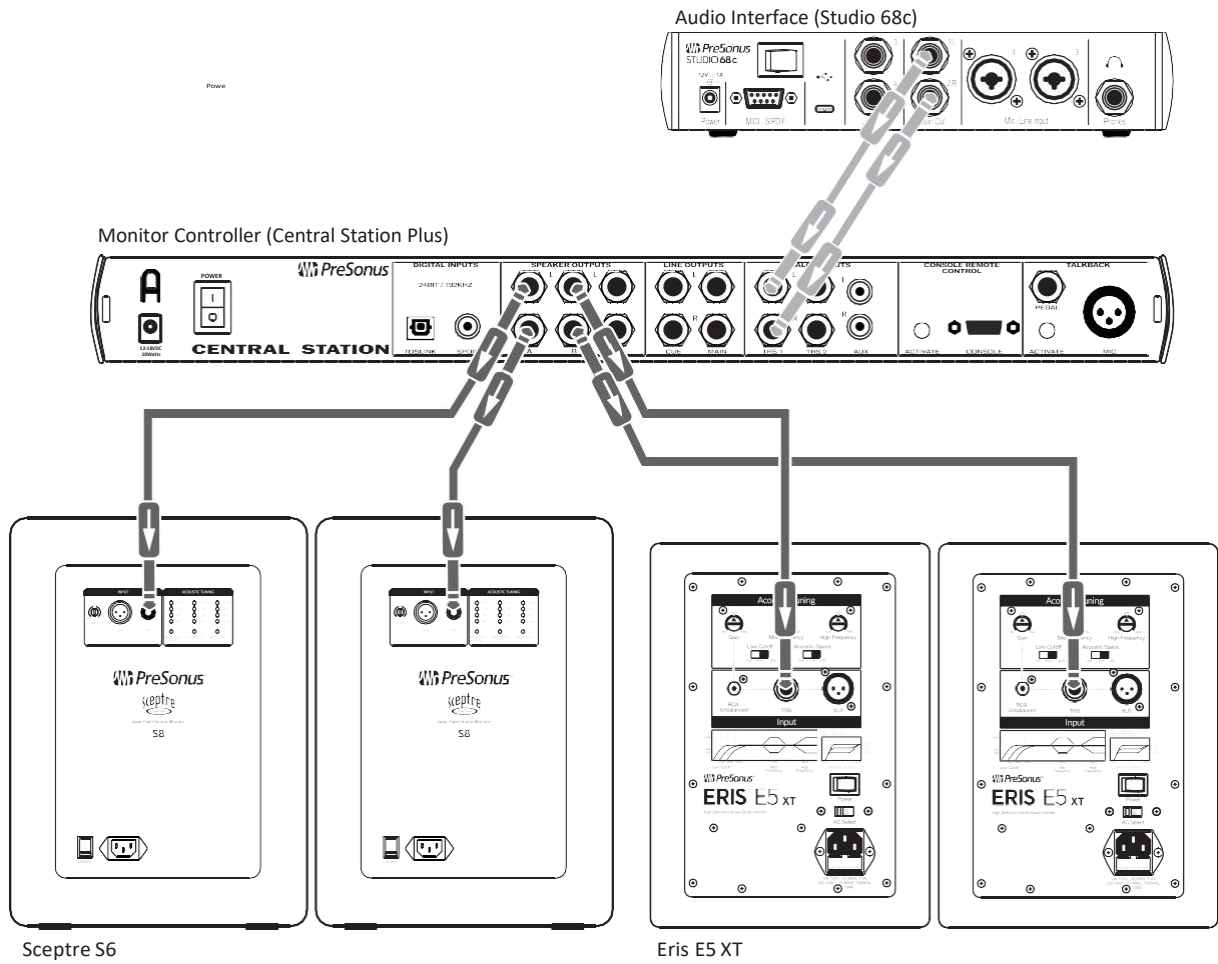

## 3 Application Guide 应用指南

### 3.1 Monitor Placement and Acoustic Space Settings 监视器的放置和声学空间的设置

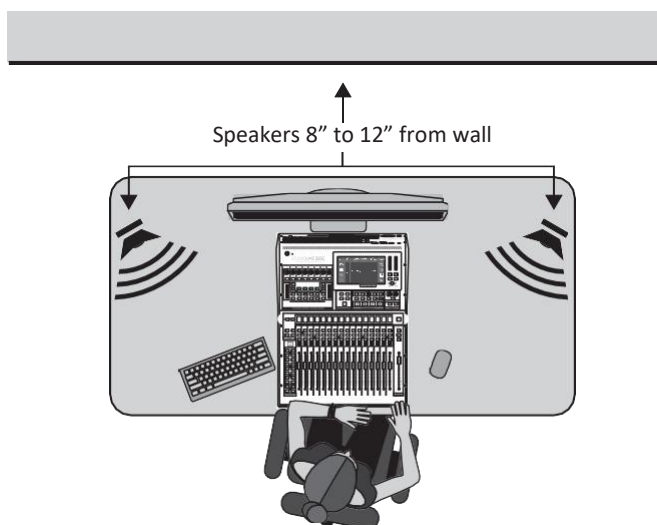

Before placing your studio monitors in your mixing environment, position your desk or monitor stands so that your speakers will be at least 8 to 12 inches away from walls and corners. This will be adequate to prevent sound waves from hitting the wall and reflecting back to you, causing phase cancellation and other potentially harmful acoustic interactions. This might not always be possible, and there are some ways to mitigate cramped mixing spaces.

在将录音室监听音箱放置在混音环境中之前，请将您的桌子或监听音箱支架放置在离墙壁和角落至少8至12英寸的地方。这将足以防止声波撞到墙上并反射到你身上，造成相位抵消和其他潜在的有害声学交互作用。这可能并不总是可能的，有一些方法可以缓解拥挤的混音空间。

When a monitor is placed close to a wall, or in a corner, the low frequencies tend to be emphasized more than if the monitor is some distance away from any room boundary. Commonly referred to as "boundary bass boost," it is most pronounced if the monitor is in a corner and less pronounced, but still present, if the monitor is near one wall. While an increased bass response may be desirable in a listening environment, for studio mixing this can cause mixing to sound too bright when played on consumer stereo systems because the audio engineer will instinctively reduce the bass content in the mix to counterbalance for what they are hearing in the studio.

当监听器靠近墙壁或放在角落时，低频往往比监听器离房间边界有一段距离时更能得到强调。通常被称为"边界低音增强"，如果监听器在角落里，它是最明显的，如果监听器靠近一面墙，则不太明显，但仍然存在。虽然在聆听环境中，增加低音响应可能是可取的，但对于录音室混音来说，这可能会导致混音在消费者立体声系统上播放时听起来太亮，因为音频工程师会本能地减少混音中的低音内容，以平衡他们在录音室中听到的内容。

To compensate for this phenomenon, every PreSonus studio monitor is equipped with an Acoustic Space control that cuts all frequencies below 800 Hz by a specified amount:

- If your Eris XT studio monitors are close to the corners of the room, start by setting the Acoustic Space switch to -4 dB. This will provide the most bass attenuation.
- When Eris XT studio monitors are placed closer to the back wall, set the Acoustic space switch to -2 dB.
- If your mix environment affords enough space for your studio monitors to be placed away from the room's boundaries, leave the Acoustic Space switch at 0 dB as no bass attenuation should be necessary.

为了补偿这种现象，每台PreSonus录音室监听器都配备了一个声学空间控制，可以将800赫兹以下的所有频率削减一个特定的量。

-如果您的Eris XT录音室监听器靠近房间的角落，首先将声学空间开关设置为-4dB。这将提供最大的低音衰减。

-当Eris XT演播室监听器靠近后墙时，将声学空间开关设置为-2分贝。

-如果你的混音环境有足够的空间让你的录音室监听器远离房间的边界，让声学空间开关保持在0分贝，因为没有必要进行低音衰减。

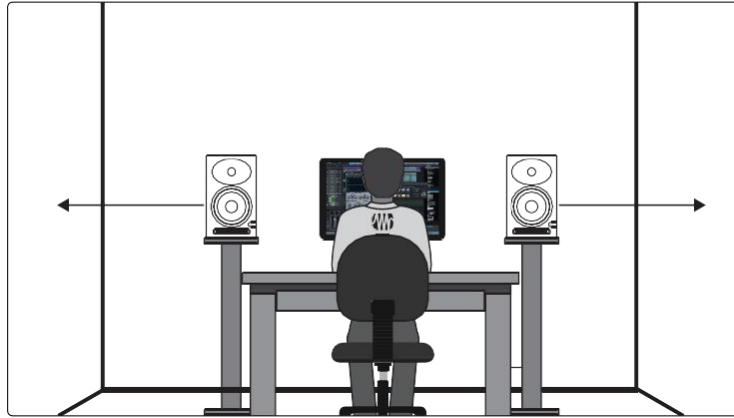

If possible, your mix position should be placed on the center of a wall as this will provide a more balanced listening position. Place your speakers so that they are the same distance from the sides of the room. That is, if your left speaker is six feet from the wall to the left and two feet from the wall behind, your right speaker should be six feet from the wall to the right and two feet from the wall behind. By centering your mix position, your monitor system will provide more reliable low-frequency intelligibility. In a rectangular room, it is best to set up along one of the long walls, especially in a smaller room. This will minimize problems caused by side wall reflections.

如果可能的话，你的混音位置应该放在墙的中央，因为这将提供一个更平衡的聆听位置。放置你的扬声器，使它们与房间的两侧保持相同的距离。也就是说，如果你的左扬声器离左边的墙六英尺，离后面的墙两英尺，你的右扬声器应该离右边的墙六英尺，离后面的墙两英尺。通过将你的混音位置居中，你的监听系统 系统将提供更可靠的低频清晰度。在一个长方形的房间里，最好是沿着其中一面长墙设置，尤其是在一个较小的房间里。这将最大限度地减少由侧墙反射引起的问题。

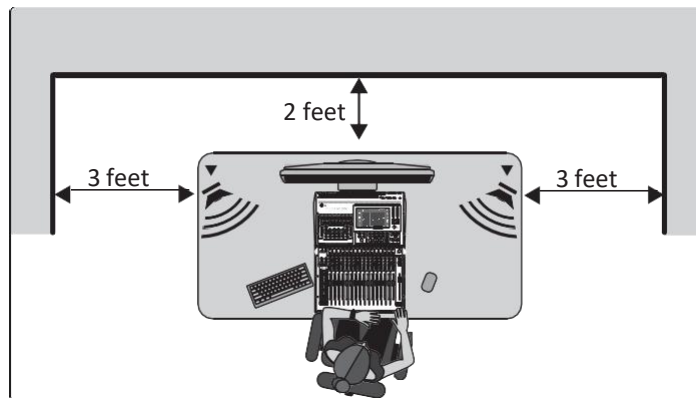

Just like it's not a good idea to set up your mix position in a corner, it's not a good idea to create a corner with your mix position. Make sure the distance from the speaker to the wall behind it is different than the distance from the side wall closest to it. For example, if your left speaker is one foot from the wall to its left, it shouldn't also be one foot from the wall behind it.

The Eris XT's focused EBM waveguide design ensures wider horizontal coverage with a tight vertical dispersion that helps to limit early reflections from your desk or console. Unlike other Eris monitors that can be placed horizontally or vertically, this design requires that the Eris XT monitors always be placed in their vertical orientation.

就像把混音位置设置在角落里不是一个好主意一样，用混音位置制造一个角落也不是一个好主意。确保扬声器到后面墙壁的距离与离它最近的侧墙的距离不同。例如，如果你的左边扬声器离它左边的墙有一英尺，那么它离它后面的墙也不应该有一英尺。

Eris XT的集中式EBM波导设计确保了更广泛的水平覆盖和更紧密的垂直扩散。

覆盖范围，同时具有紧密的垂直扩散，有助于限制来自桌面或控制台的早期反射。与其他可以水平或垂直放置的Eris显示器不同，这种设计要求Eris XT显示器始终以其垂直方向放置。

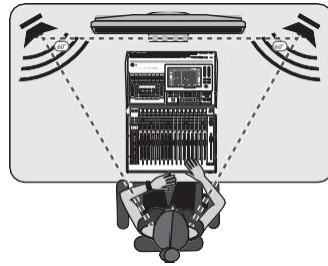

Whenever people talk about listening to speaker systems, they talk about the "sweet spot." As mentioned earlier, this is the middle position between the two sides of a stereo system, where the speakers overlap, and it is where the stereo image will be the best.

每当人们谈及聆听扬声器系统时，他们都会谈论 "甜蜜点"。如前所述，这是一个立体声系统的两边之间的中间位置。如前所述，这是一个立体声系统两边的中间位置，扬声器重叠的地方，也是立体声图像最好的地方。

Creating the sweet spot is relatively easy. Simply angle, or "toe-in," each speaker so that the tweeters form an equilateral triangle with your head—that is, the speakers are the same distance from each other as they are from you. The monitors should be angled, or "toed in," so that they are each directed to an ear, rather than pointed straight ahead.

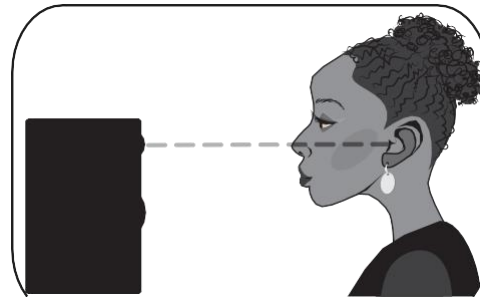

Ideally, near-field studio monitors like the Eris XT-series should be placed so that the high-frequency drivers (commonly known as 'tweeters') are at the same height as your ears when you are seated in the mix position.

High-frequency content is much more directional than low frequency content. Because of this, you can more accurately hear what is happening if the high frequencies are directed at your ear. Once you have created the sweet spot, sit down and make sure that your ears are level with the center of tweeter.

创造最佳听音位置是相对容易的。只需将每个扬声器的角度或"脚尖"对准，使高音扬声器与您的头部形成一个等边三角形，也就是说，扬声器之间的距离与您的距离相同。监视器应该有一定的角度，或者说"趾高气扬"，使它们各自指向一只耳朵，而不是直指前方。

理想情况下，像Eris XT系列这样的近场录音室监听设备应该放置在当你坐在混音位置时，高频驱动器（通常被称为"高音扬声器"）与你的耳朵处于同一高度。

高频内容比低频内容更具有方向性。正因为如此，如果高频指向您的耳朵，你可以更准确地听到正在发生什么。一旦你建立了甜蜜点。坐下来，确保您的耳朵与高音喇叭的中心持平。

### 3.2 Calibrating Using 85 dB SPL "Standard" Reference 使用85dB SPL "标准"参考值进行校准

After you have properly positioned your studio monitors and listening position, it is helpful to set all the levels in your studio so that you are optimizing every component. Taking the time to properly calibrate your speakers can be very valuable in this respect and will also give you a great starting point to troubleshoot or fine-tune your mixing environment.

在你正确定位了你的演播室监听器和聆听位置之后，在你的演播室中设置所有的电平是很有帮助的，这样你就可以优化每个组件。花点时间正确地校准你的扬声器，在这方面是非常有价值的，也会给你一个很好的起点来解决故障或微调你的混音环境。



The main purpose of speaker calibration is to ensure that a specific metered audio level in your DAW or on your mixer equals a predetermined SPL in your studio environment. Depending upon the method and reference levels used during calibration, proper calibration can help reduce unwanted noise, minimize the risk of damage to your studio monitors and to your ears, maximize the reference capabilities of different speaker types, and ensure you hear the audio as accurately as possible.

扬声器校准的主要目的是确保在你的DAW或调音台上的特定计量音频电平等于你的演播室环境中预定的声压级。根据校准过程中使用的方法和参考电平，正确的校准可以帮助减少不必要的噪音，最大限度地减少对你的演播室监听器和你的耳朵的损害风险，最大限度地提高不同类型的扬声器的参考能力，并确保你尽可能准确地听到音频。

When calibrating reference monitors in a studio, the acoustic level or sound pressure level (SPL) should be measured from the mix position at seated ear height. There are an assortment of great SPL metering apps on the market for smartphones, and many are free! You can also find accurate SPL meters at your favorite local electronics-supply store.

在演播室中校准参考监听器时，应从坐着的耳朵高度的混音位置测量声级或声压级（SPL）。市场上有各种优秀的智能手机声压级测量应用程序，而且很多都是免费的！也可以在您喜欢的当地电子用品商店找到准确的声压级测量仪。



The SPL meter should be held at arm's length, with the microphone pointed at the center point between the left and right speakers (where your head will be), angled at 45 degrees to ensure an accurate reading. If your SPL meter is also your cell phone, make sure your finger or cell phone case isn't covering the mic!

声压级计应与手臂保持一定距离，麦克风对准左右扬声器之间的中心点（你的头会在那里），角度为45度，以确保读数准确。如果你的声压级计也是你的手机，请确保你的手指或手机壳没有覆盖住麦克风！

You should calibrate the right and left monitors independently to ensure that both monitors are set to the same acoustic level. This will ensure that your stereo mixes are balanced and will translate well across different speaker systems.

The goal of this Standard Reference Calibration is to ensure that when the output meters in your DAW or mixer register 0 dB, the SPL at your mix position is 85 dB.

你应该独立地校准右边和左边的监听器，以确保两个监听器被设置为相同的声学水平。这将确保你的立体声混音是平衡的，并能在不同的扬声器系统中很好地转换。

这个标准参考校准的目标是确保当你的DAW或调音台的输出表记录到0dB时，你的混音位置的声压级是85dB。

1. Connect the main outputs of your audio source to your studio monitors. The left output should be connected to the speaker on your left. The right output should be connected to the speaker on your right.
2. Begin by turning the input sensitivity of your Eris XT monitors to the lowest setting.

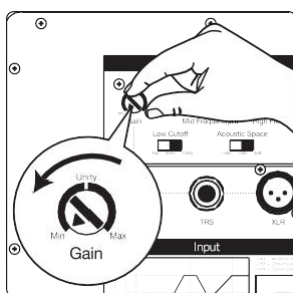

3. Turn the output of your audio source (audio interface, mixer, or speaker-management device) to its lowest setting.
 

**Note:** If you have any outboard processors (EQs, limiter, etc.) connected between the audio source and your monitors, disconnect or bypass them. If your audio source is a mixer, make sure that it is zeroed out.
4. Play 20 Hz to 20 kHz full-bandwidth pink noise at 0 dB through the outputs of your primary audio source.

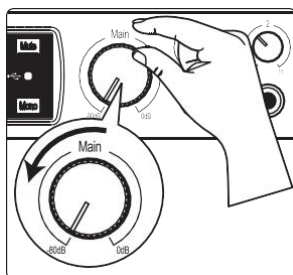

5. Turn up the outputs of your primary audio source to the unity gain setting. “Unity gain” is the setting at which the signal level is neither boosted nor attenuated. It is usually marked by a “0” or a “U” on the audio device’s level fader or knob. In many digital interfaces and digital devices, the device’s maximum level is also its unity gain setting. Please consult your audio device’s user’s manual or the manufacturer’s Website for more information on its levels and adjustments. You should not hear the pink noise. If you do, repeat step 2.

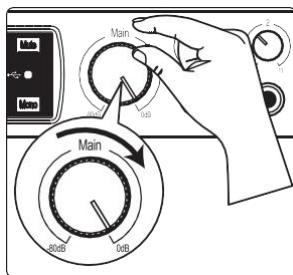

6. While measuring the output level with an SPL meter, begin slowly increasing the input sensitivity (volume) of your left speaker until the acoustic level of the test tone playing reaches 82 dB SPL. When both speakers play simultaneously, the overall SPL will increase by about +3 dB (85 dB).
7. Power down your left speaker.
8. Slowly increase the input sensitivity (volume) of your right speaker until the acoustic level of the test tone playing reaches 82 dB SPL.

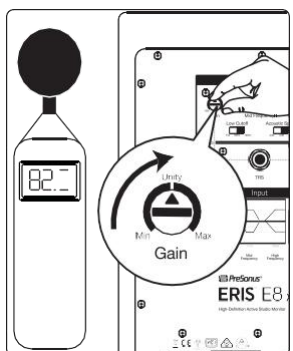

9. Stop the pink noise and turn your left speaker back on. Play some program music you are familiar with through your speakers and sit down in your mix position. You may need to fine-tune your speaker placement until the sound is balanced and you have a nice, wide sweet spot from which to mix.

**Note:** *If 85 dB is too loud for your room, either because of noise constraints or because the room is too small, you can redo the above calibration steps and dial in each speaker to 79 dB instead. The important thing is that both speakers are set to the same SPL level, not the level itself.*

1. 将你的音源的主输出连接到你的演播室监听。左边的输出应该连接到你左边的扬声器上。右边的输出应该连接到右边的扬声器上。

2. 首先将Eris XT监听音箱的输入灵敏度调到最低设置。

3. 将你的音源（音频接口、混音器或扬声器管理设备）的输出调到最低设置。

注意：如果你在音源和监听之间有任何外置处理器（均衡器、限制器等）连接，请断开或绕过它们。如果你的音源是调音台，请确保它已经归零。

4. 通过你的主要音源的输出，在0分贝处播放20赫兹至20千赫兹的全带宽粉红噪声。

5. 把你的主要音源的输出调到统一增益的设置。"统一增益"是指信号电平既不提升也不衰减的设置。它通常在音频设备的电平推子或旋钮上以"0"或"U"标记。在许多数字接口和数字设备中，设备的最大电平也是其统一的增益设置。请查阅你的音频设备的用户手册或制造商的网站，了解更多关于其电平和调整的信息。你不应该听到粉红噪音。如果你听到了，请重复第2步。

6. 在用声压计测量输出电平的同时，开始慢慢增加左边扬声器的输入灵敏度（音量），直到播放的测试音的声级达到82dB SPL。7. 关闭您的左扬声器的电源。

7. 关闭您的左扬声器的电源。

8. 慢慢增加你的右扬声器的输入灵敏度（音量），直到播放的测试音的声学水平达到82dB SPL。

9. 停止粉红噪音，重新打开你的左扬声器。通过你的扬声器播放一些你熟悉的节目音乐，然后坐在你的混音位置上。你可能需要对你的扬声器位置进行微调，直到声音平衡，你有一个很好的、宽阔的甜蜜点来进行混音。

注意：如果85分贝对你的房间来说太大，无论是因为噪音限制还是因为房间太小，你可以重新进行上述校准步骤，将每个扬声器拨到79分贝。重要的是，两个扬声器都被设置为相同的声压级，而不是级别本身。

## 4.1 Technical Specifications

Owner's Manual

## 4 Resources 相关资源

### 4.1 Technical Specifications 技术参数

Inputs	1- Balanced XLR 1- Unbalanced RCA
--------	--------------------------------------

Performance 性能	E5XT	E7XT	E8XT
Frequency Response 频率响应	48Hz to 20kHz	42 Hz to 22 kHz	35 Hz to 20 kHz
Crossover Frequency 频率	3kHz	2.5 kHz	2.2 kHz
LF Amplifier Power 低频放大器功率	45W	70W	75W
HF Amplifier Power 高频放大器功率	35W	60W	65W
Peak SPL (@ 1 meter) 峰值声压级 (@1米)	102 dB	104 dB	105 dB
LF Driver 低频驱动器	5.25"	6.5"	8"
HF Driver 高频驱动器	1" Silk Dome	1.25" silk dome	1.25" silk dome

### User Controls 用户控制

Volume Range 音量范围	A-Type Taper
MF Control 中频控制	-6 to +6 dB
HF Control 高频控制	-6 to +6 dB
Low Cut 低频切除	Flat, 80 Hz, 100 Hz External mains fuse
Acoustic Space 声学空间	Flat, -2 dB, -4 dB
Protection 防护	RF interference Output-current limiting Over-temperature Turn-on/off transient Subsonic filter External mains fuse
Power 电源	100-120V ~50/60 Hz or 220-240V ~50/60 Hz
Cabinet 箱体	Vinyl-laminated, medium-density fiberboard

### Physical 物理

Width 宽度 (毫米)	8"(203mm)	9.45"(240mm)	9.75"(248 mm)
Depth 深度 (毫米)	9"(229mm)	9.5"(242 mm)	11.5"(292 mm)
Height 高度 (毫米)	11"(279mm)	14.4"(365 mm)	16" (406 mm)
Weight 重量 (公斤)	11lbs(5kg)	18.5 (8.37 kg)	23 lbs (10.4 kg)

## 4.2 Troubleshooting 故障排除

**No Power.** First ensure that your Eris XT studio monitor is plugged in. If it's connected to a power conditioner, verify that the power conditioner is turned on and functioning. If problem still exists, disconnect the power cable from your studio monitor and check the fuse on the back panel.

The fuse housing is located directly beneath the IEC power cable connection. A blown fuse may look black on the inside or the wire inside might appear broken. A very black fuse is a sign that something may have shorted out. Try replacing the fuse with a new one. The E5XT uses a T1L fuse. The Eris E7XT and E8XT use a T2L fuse. If the fuse blows again, you will need to contact PreSonus for a repair.

**No audio.** If your Eris XT studio monitor appears to power on but you hear no sound when playing audio from your audio source (the lights are on but nobody's home), first make sure that the cable connecting your audio source to the monitor is working correctly. Also, verify that the Input Gain control is set to provide enough amplitude for the signal.

**Hum.** Usually, hum is caused by a ground loop. Verify that all audio equipment is connected to the same power source. If you are not using a power conditioner, we highly recommend that you add one. Not only will this help to minimize hum, it will better protect your equipment from power surges, brownouts, etc.

Use balanced cables whenever possible. If your audio device does not offer a balanced output, you can connect it to a direct box, which will provide a ground-lift switch and a balanced output. Finally, make sure that your audio cables are not run near power cables, and use cables that are the appropriate length for your application. Using cables that are too long not only increases the risk of noise, it increases the likelihood that the cables are coiled, which will essentially create an antenna that picks up all kinds of audio interference.

**没有电源。** 首先确保你的Eris XT演播室监听器已经插上电源。如果它连接到一个电源调节器上，请确认电源调节器已经打开并正常工作。如果问题仍然存在，从你的演播室监视器上断开电源线，检查后面板上的保险丝。

保险丝外壳位于 IEC 电源线连接处的正下方。熔断的保险丝内部可能看起来是黑色的，或者内部的电线可能出现断裂。保险丝非常黑是一个迹象，表明可能有什么东西短路了。试着用一个新的保险丝来替换。E5XT使用一个T1L保险丝。Eris E7XT和E8XT使用的是T2L保险丝。如果保险丝再次熔断，你将需要联系PreSonus 进行维修。

**没有音频。** 如果你的Eris XT演播室监听器似乎开机了，但当你从音源播放音频时，你没有听到任何声音（灯亮了，但家里没人），首先要确保连接音源和监听器的电缆是正常的。另外，确认输入增益控制的设置，为信号提供足够的振幅。

**嗡嗡声。** 通常情况下，嗡嗡声是由接地回路引起的。确认所有的音频设备都连接到同一个电源上。如果你没有使用电源调节器，我们强烈建议你添加一个。这不仅有助于最大限度地减少嗡嗡声，而且可以更好地保护你的设备免受电源浪涌、断电等影响。

尽可能地使用平衡电缆。如果你的音频设备不提供平衡输出，你可以把它连接到一个直接盒上，这将提供一个接地升降开关和一个平衡输出。最后，确保你的音频电缆不靠近电源线，并使用适合你的应用的长度的电缆。使用太长的电缆不仅会增加噪音的风险，而且会增加电缆盘绕的可能性，这基本上会形成一个天线，接收各种音频干扰。

# Added bonus: PreSonus' previously Top Secret recipe for...

## Red Beans and Rice 额外的奖励: PreSonus 以前的绝密配方为...

### 红豆和大米

#### Ingredients:

- 1 lb dried Red Kidney Beans
- 1 large onion (diced)
- 3 celery stalks (diced)
- 1 large green bell pepper (diced)
- 6-8 C vegetable stock
- 1 Tbs. Old Bay seasoning
- ½ fresh parsley
- 2 tsp. kosher salt
- 2 Tbs. olive oil
- 1 smoked ham hock (optional)

#### Cooking instructions:

1. Rinse red beans in cold water.
2. In a pressure cooker, heat olive oil on medium high. Sauté onion, celery, bell pepper, beans, and ham hock (if using) until onions are translucent.
3. Stir in Old Bay, parsley, and salt.
4. Add vegetable stock until beans and vegetables are covered.
5. Close pressure cooker and bring to full pressure on high heat.
6. Reduce heat to low while maintaining full pressure. Cook for 40 minutes.
7. Allow pressure to drop naturally (20-30 minutes).
8. Remove lid and crush with a potato masher until creamy.
9. Correct seasoning with salt and pepper if necessary.
10. Serve over rice with hot sauce and grilled Andouille sausage (optional).

#### 成分:

- 1磅干红腰豆
- 1个大洋葱(切丁)
- 3根芹菜茎(切丁)
- 1个大的绿灯笼椒(切丁)
- 6-8C蔬菜汤
- 1汤匙老海湾调料
- 半根新鲜欧芹
- 2茶匙犹太盐
- 2汤匙橄榄油
- 1根烟熏火腿肠(可选)

## 烹饪说明：

- 1.用冷水冲洗红豆。
- 2.在一个高压锅中，用中高火加热橄榄油。煸炒洋葱、芹菜、甜椒、豆子和火腿肠（如果使用），直到洋葱呈半透明状。
- 3.加入老海湾、欧芹和盐进行搅拌。
- 4.加入蔬菜汤，直到豆子和蔬菜被覆盖。
- 5.关闭高压锅，用大火将压力升至全压。
- 6.在保持全压的情况下，将热量降至低。煮**40**分钟。
- 7.让压力自然下降（**20-30**分钟）。
- 8.揭开盖子，用土豆泥压碎，直到呈奶油状。
- 9.如有必要，用盐和胡椒粉纠正调味品。
- 10.在米饭上加辣酱和烤安杜尔香肠（可选）。

# Eris® XT-Series E5 XT / E7 XT / E8 XT

## High-Definition Near Field Studio Monitors

Owner's Manual 用户手册

